

DF-FCQ ADJUSTABLE PRIORITY FLOW CONTROL VALVE

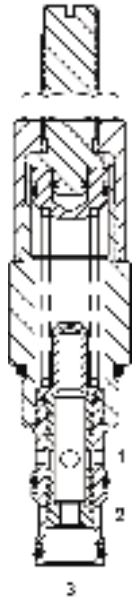

DESCRIPTION

10 size, 7/8-14 thread, "Delta" series, adjustable priority flow control valve.

OPERATION

The DF-FCQ allows pressure compensated flow from (3) to (1) regulated by the pressure present at (3). Excess flow bypasses out (2).

FEATURES

- Hardened parts for long life.
- Industry common cavity.



Test data shown on this sheet, for condition of port (2) to tank. Data on next page, for condition of port (3) to tank.

HYDRAULIC SYMBOL

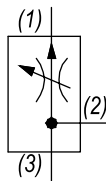

PERFORMANCE

Actual Test Data (Cartridge Only)

VALVE SPECIFICATIONS

Nominal Flow	10 GPM (38 LPM)
Rated Operating Pressure	3000 PSI (207 bar)
Viscosity Range	36 to 3000 SSU (3 to 647 cSt)
Filtration	ISO 18/16/13
Media Operating Temp. Range	-40° to 250°F (-40° to 120°C)
Weight	.56 lbs (.25 kg)
Operating Fluid Media	General Purpose Hydraulic Fluid
Cartridge Torque Requirements	30 ft-lbs (40.6 Nm)
Cavity	DELTA 3W
Cartridge Form Tool (Finishing)	40500001
Seal Kit	21191206

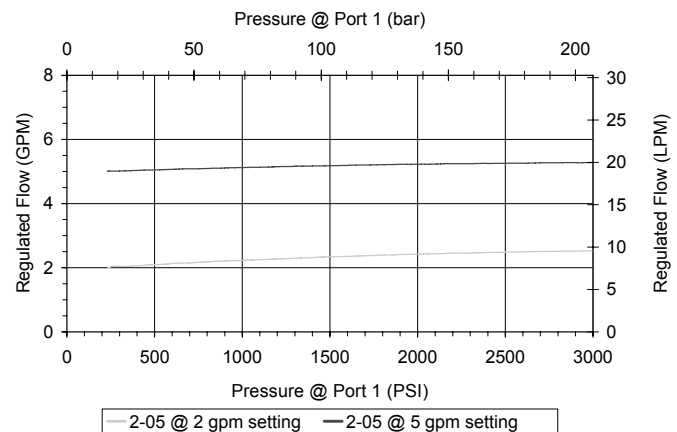
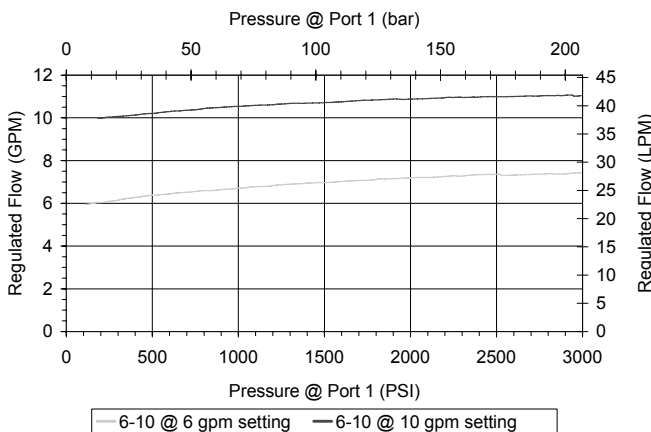

WARNING: the specifications/application data shown in our catalogs and data sheets are intended only as a general guide for the product described (herein). Any specific application should not be undertaken without independent study, evaluation, and testing for suitability.



4484 Boeing Drive Rockford, IL 61109 • USA • Phone +1 (815) 397-6628 • Fax +1 (815) 397-2526
 mail: delta@delta-power.com • www.delta-power.com



Via Malavolti, 36 • 41122 Modena • ITALY • Phone +39 (059) 254895 • Fax +39 (059) 253512
 mail: tecnord@tecnord.com • www.tecnord.com

MECHANICAL FLOW CONTROLS

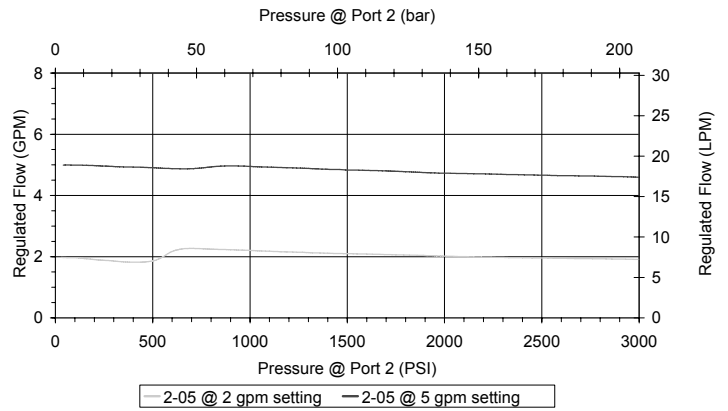
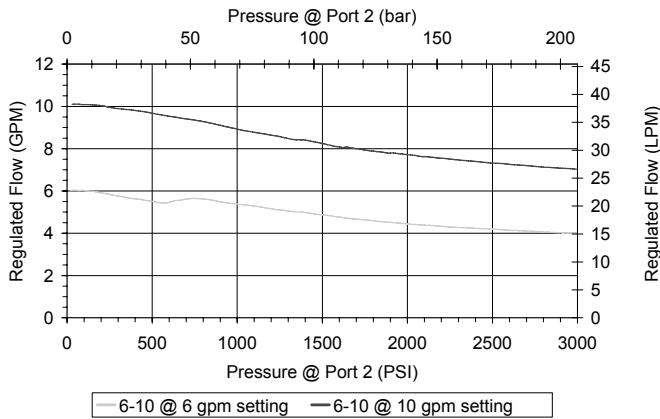

DIMENSIONS

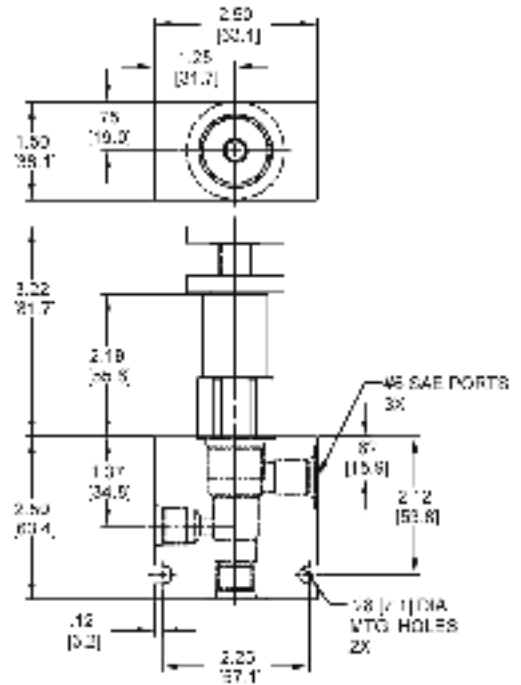
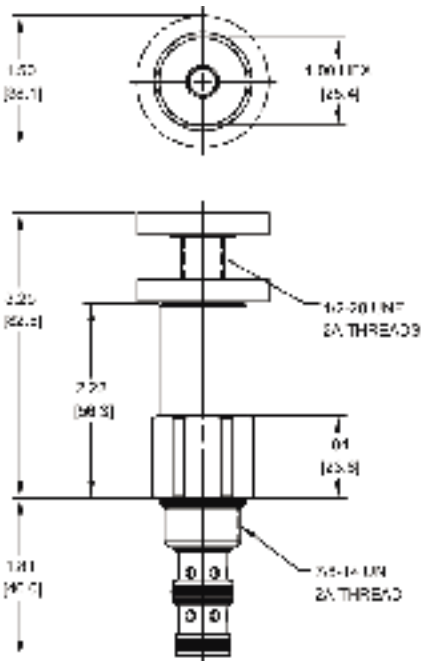

Body Weight: .76 lbs (.35 kg)

ORDERING INFORMATION

<p>DF-FCQ -</p> <p>OPTIONS</p> <p>Buna Standard 00</p> <p>Viton Standard V0</p> <p>Buna, Knob OK</p> <p>Viton, Knob VK</p>	<p>-</p> <p>-</p> <p>-</p>	<p>BODIES</p> <p>Blank Without Body</p> <p>N 1/4" NPTF Ports</p> <p>S #6 SAE Ports</p> <p>FLOW RANGE</p> <p>2-05 2 to 5 GPM</p> <p>6-10 6 to 10 GPM</p>
----------------------------------------------------------------------------------------------------------------------------------------------------------------------	----------------------------	---------------------------------------------------------------------------------------------------------------------------------------------------------------------------------------------------

11/6 / 2020

WARNING: the specifications/application data shown in our catalogs and data sheets are intended only as a general guide for the product described (herein). Any specific application should not be undertaken without independent study, evaluation, and testing for suitability.



4484 Boeing Drive Rockford, IL 61109 • USA • Phone +1 (815) 397-6628 • Fax +1 (815) 397-2526
mail: delta@delta-power.com • www.delta-power.com



Via Malavolti, 36 • 41122 Modena • ITALY • Phone +39 (059) 254895 • Fax +39 (059) 253512
mail: tecnord@tecnord.com • www.tecnord.com